

## NOISE MEASUREMENT SET-UPS FOR FLUCTUATIONS-ENHANCED GAS SENSING

Mateusz Kotarski, Janusz Smulko

Gdansk University of Technology, Faculty of Electronics, Telecommunication and Informatics, G. Narutowicza 11/12, 80-952 Gdańsk, Poland (✉ [jmulko@eti.pg.gda.pl](mailto:jmulko@eti.pg.gda.pl), +48 58 348 6095, [kotarski@interecho.com](mailto:kotarski@interecho.com))

### Abstract

Resistance fluctuations observed as voltage fluctuations across resistance gas sensors can increase the sensibility and selectivity of gas sensing. This conclusion leads to the question how to prepare in practice a cheap measurement system for gas detection when resistance gas sensors of various resistance are applied. Therefore it is valuable to consider different noise measurement systems that would apply fluctuation-enhanced gas sensing. This study presents two solutions of noise systems that can be used for noise measurements in Taguchi gas sensors currently available on the market and the prototype monosized nanoparticle gas sensors having much greater DC resistance than the sensors currently on sale.

Keywords: gas sensors, gas detection, noise.

© 2009 Polish Academy of Sciences. All rights reserved

### 1. Introduction

Resistance gas sensors are very popular, cheap and stable sensors currently available on the market. These sensors consist of a metal oxide layer (*e.g.*: SnO<sub>2</sub>, TiO<sub>2</sub>, WO<sub>3</sub>, ZnO) that exhibits gas sensitivity at elevated temperatures. This type of sensors is called Taguchi gas sensors (TGS) and was proposed in the seventies [1, 2]. These sensors are widely used in security systems but we can still expect an increase of their application due to improved living standard and the need of air quality monitoring or more severe demands for security in public places.

The commercial sensor comprises a porous gas sensitive layer of nanoparticle grains that cover a tiny pipe with a heater placed inside to limit heat dissipation and decrease energy consumption (Fig. 1). When ionized oxygen is removed from the ambient atmosphere the potential barrier between the grains decreases that results in decreased DC resistance (Fig. 2).

Various gases manifest their presence in the ambient atmosphere in the same way by decreasing the DC resistance. Thus, we can not determine the composition of the present gases by monitoring the DC resistance of a single gas sensor. This limitation is the main driving force for searching for new methods that would deliver more information from a single gas sensor.

The recently proposed new method explores noise voltage measurements across a gas sensor as a source of additional information that would improve the selectivity and sensibility of gas detection [3, 4]. The research results presented in literature were obtained by using expensive laboratory equipment and this limits the practical use of the method. Thus, this paper studies possible simplifications of the measurement setup to spread its potential usage to numerous practical applications.

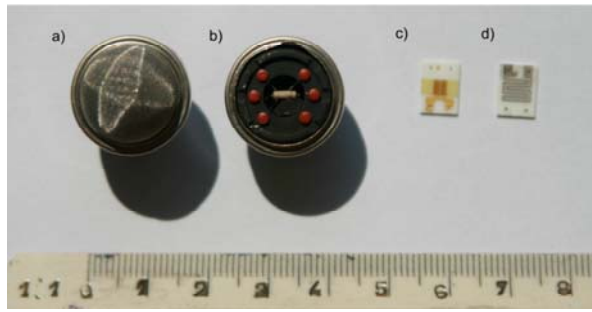

Fig. 1. Taguchi gas sensors produced by Figaro company: (a) purchased sensor, (b) with uncovered gas sensitive layer and contacts, (c) a prototype of monosized nanoparticle gas sensor and (d) its platinum heater.

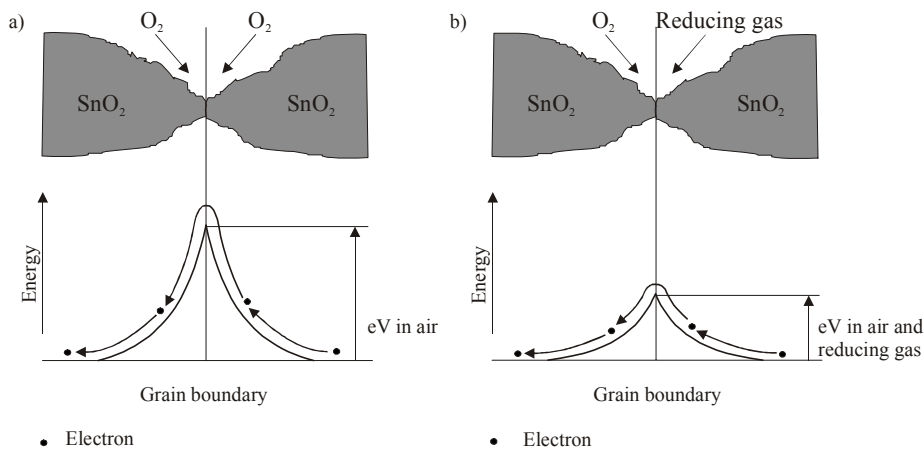

Fig. 2. Model of potential barrier between grains of metal oxide  $\text{SnO}_2$  in a) air and b) other reducing gases.

## 2. Noise in gas sensors

The commercial TGS gas sensors exhibit DC resistance in the presence of air, starting usually from a few  $\text{k}\Omega$  and finishing up to three hundreds of  $\text{k}\Omega$  when heated to the elevated temperature of a few hundred degrees Celsius. The gas sensors exhibit  $1/f$  resistance noise that dominates usually at frequencies below a few kHz. This noise is generated mainly by diffusion of ambient gases inside the porous sensor structure due to random fluctuations of the potential barrier between the grains [5]. The grains have various size and in commercial sensors start from a few nm and do not exceed hundreds of nm.

The resistance fluctuations are observed as voltage fluctuations across the sensor that is polarized by a DC voltage up to a few volts. The voltage fluctuations across the sensor are proportional to the squared DC voltage polarizing the sensor (Fig. 3) that proves that its origin is linked with the above suggested resistance fluctuations. For example, we can expect voltage fluctuations across the TGS gas sensor (e.g. TGS 286-636 [4]) polarized by a reasonable DC voltage of 3 V with an intensity above  $2 \cdot 10^{-15} \text{ V}^2/\text{Hz}$  at a frequency of  $f = 1 \text{ kHz}$ . Detailed example data for various commercial TGS gas sensors are gathered in Table 1. We can conclude that the observed noise intensity is two orders or even more greater than the noise introduced to the measurement system that explores a low-noise voltage preamplifier (e.g.  $1.6 \cdot 10^{-17} \text{ V}^2/\text{Hz}$  input noise at 1 kHz for the Stanford SR 560 voltage amplifier). Thus, it can be suggested that in practice a less expensive amplifier could be used even with a more intensive inherent noise source as the presented laboratory one. Additionally, the sampling can be done by an economic A/D converter being part of a cheap microcontroller with a resolution limited to ten bits.

Table 1. Power spectral density  $S_u(f)$  of voltage fluctuations observed for various TGS gas sensors currently available on the market at a frequency of  $f=60$  Hz and sensor DC 1 V polarization voltage.

Gas sensor	Ambient atmosphere	$S_u(f)$ [ $V^2/Hz$ ]
TGS 2602 (NH <sub>3</sub> , H <sub>2</sub> S, C <sub>2</sub> H <sub>5</sub> -OH)	1,5 ppm of H <sub>2</sub> S	$4,0 \cdot 10^{-14}$
TGS 812 (propan, butan, CO)	Synthetic air	$6,0 \cdot 10^{-14}$
RS 286-636 (CO)	380 ppm of H <sub>2</sub>	$5,0 \cdot 10^{-12}$
RS 286-648 (NO)	70 ppm of ethanol	$3,3 \cdot 10^{-13}$
TGS 816 (combustible gases)	Synthetic air	$3,5 \cdot 10^{-14}$
TGS 823 (ethanol, acetone)	Synthetic air	$5,0 \cdot 10^{-13}$
TGS 825 (H <sub>2</sub> S)	Synthetic air	$1,0 \cdot 10^{-14}$

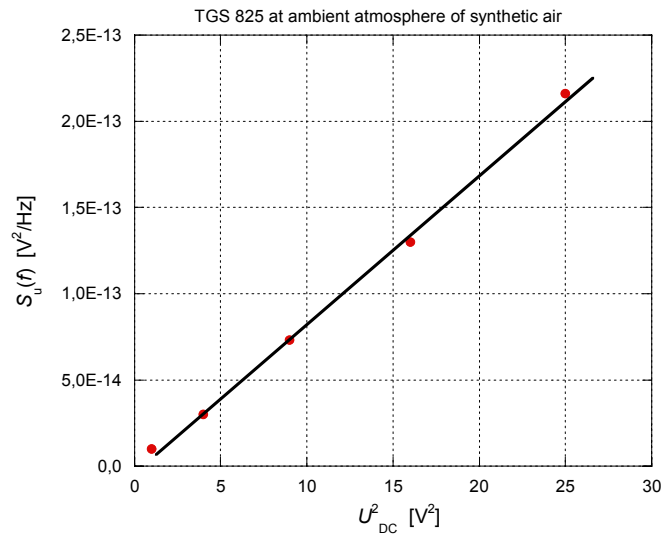

Fig. 3. Power spectral density  $S_u(f)$  of voltage fluctuations measured across the TGS 825 voltage sensor polarized by  $U_{DC}$  at ambient atmosphere of synthetic air at a frequency of  $f=62.5$  Hz.

Gas sensibility can be improved when the gas sensitive layer comprises smaller grains and is thin enough to assure that even a tiny amount of gas would influence the physical properties. These conditions lead to an increase of the sensor DC resistance, even up to hundreds of M $\Omega$  in the prototype sensors, when the layer is only 1  $\mu$ m thick and consists of monosized grains of a few nm [6]. Then, resistance fluctuations of these sensors are more difficult to register and another setup has to be used than the one applied for commercial TGS sensors.

### 3. Noise measurement characteristics

The laboratory measurements of resistance fluctuations in TGS gas sensors are performed by using an expensive low noise voltage amplifier (*e.g.* Stanford SR560) and high-quality data acquisition board (*e.g.* NI PCI-4474 with 24-bit resolution of the A/D converter) with anti-aliasing filters controlled by a personal computer or a spectrum analyser (*e.g.* Stanford SR760). Fluctuation measurements in gas sensors can be done in the laboratory for a detailed study of noise phenomena but in practice this system would be too expensive. Therefore, it is worth to consider more deeply how to perform measurements and necessary signal processing using the simplified systems controlled by a cheap microprocessor.

Resistance noise is measured when the sensor is polarized by a DC voltage. Fig. 4 presents the circuit for TGS gas sensors with DC resistance up to a few hundreds of kΩ. The sensor is polarized by a battery-supplied DC voltage of up to a few volts. The bias voltage is stabilized by a low pass RC filter with a time constant of tens of seconds. The DC voltage across the sensor is measured by applying an additional RC low-pass filter that comprises a resistor  $R_1$  and capacitor  $C_1$ . The resistance of resistor  $R_1$  should be an order or two greater than that of the sensor  $R_s$  and the time constant  $R_1C_1$  should be equal to approximately a few seconds to attenuate external interference induced along the wires when the DC voltmeter is attached to  $C_1$ .

The low-frequency noise voltage  $u(t)$  observed across the gas sensor is the sum of two parallel  $1/f$  noise sources consisting of resistor  $R$  and the gas sensor  $R_s$ . Thus, the resistor  $R$  that should have a comparable resistance with  $R_s$  has to be selected as a low-noise resistor (*e.g.* precision metal film resistors characterized by a low noise index) [7]. The gas sensor that comprises a porous structure can exhibit  $1/f$  noise even a few orders greater than the parallel-attached low noise resistor  $R$ . We can prove that the observed noise is caused by  $1/f$  type resistance fluctuations of the gas sensor by changing the DC bias voltage across the sensor and comparing with a change of the noise spectrum  $S_u(f)$ . The change of  $S_u(f)$  being proportional to the square of the bias voltage  $U_{DC}$  proves that the observed noise is caused by  $1/f$  component [8].

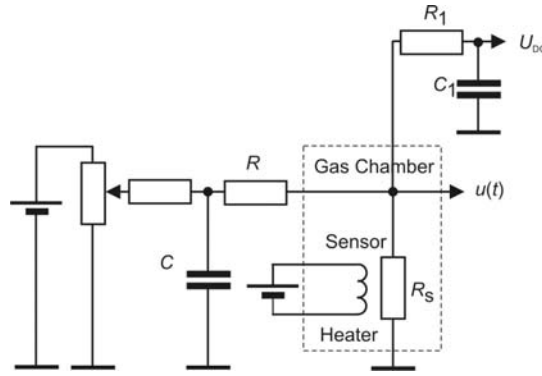

Fig. 4. The circuit for gas sensor DC biasing at resistance fluctuation measurements in TGS gas sensors characterised by a DC resistance of up to a few hundreds kΩ.

Moreover, practical experience suggests to use a linear voltage supply or even better a battery for the gas sensor heater. Voltage supplies currently available on the market use the switched-mode technique that induces serious interference across  $R_s$ . This drawback can be reduced by using an additional capacitor connected closely to the heater. Additionally, correct grounding and shielding of the system should be provided to limit other sources of interference in a similar way as during other low-signal measurements [8].

The noise voltage of the gas sensor, at the output of the presented bias circuit at frequencies where  $1/f$  noise component dominates, follows the empirical Hooge equation [9]:

$$\frac{S_u(f)}{U_{DC}^2} = \frac{S_{R_s}(f)}{R_s^2} = \frac{\alpha}{N \cdot f}, \quad (1)$$

where  $\alpha$  is a dimensionless ‘‘Hooge parameter’’ that characterizes the  $1/f$  noise level in materials and structures with macroscopically homogeneous current density,  $N$  is the total number of atoms in the sample. This empirical formula was proposed by assuming that sub-volumes of the sample space contribute independently to the  $1/f$  noise. Thus, the power

spectrum  $S_{R_s}(f)$  of the sensor resistance fluctuations should be normalized by the squared sensor resistance  $R_s$  and gives the same result as the quotient  $S_u(f)/U_{DC}^2$ . Then, we can establish a function of frequency that is proportional to the Hooge parameter and can be explored to detect various gases.

Another circuit has to be applied when the prototype nanoparticle gas sensors are investigated due to their much higher DC resistance, even up to hundreds of  $M\Omega$  [10]. The proposed circuit is presented in Fig. 5. The output voltage signal depends on fluctuations of the sensor resistance  $R_s(t)$  polarized by DC voltage  $U_{ref}$ . The circuit assures that resistance  $R_s$  drop due to change of ambient gas atmosphere does not influence the bandwidth of the applied operational amplifier. The resistance of the feedback loop resistor  $R$  has to be greater than  $R_s$  to achieve amplification of resistance fluctuations and can reach even the value of  $G\Omega$ . This means that the parasitic capacitance  $C_p$  limits the bandwidth of the applied operational amplifier up to tens of Hz only. This circuit is better than the previously proposed one [11] when the sensor was put into the feedback loop and there was no possibility to explain reasons for the observed noise intensity changes.

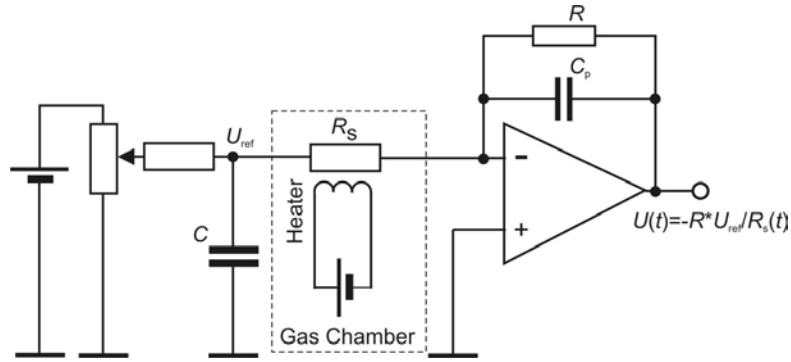

Fig. 5. The circuit for the gas sensor DC voltage bias at resistance fluctuation measurements in the prototype monosized nanoparticle gas sensors characterised by a DC resistance that exceeds hundreds of  $M\Omega$ .

The proposed circuits (Figs 4, 5) need further amplification of noise signals. We can apply a cheap low-noise voltage amplifier that uses a low-noise MOSFET transistor (e.g. 2SK170). Such a self-made voltage amplifier costs a few dollars only and has an input voltage noise below  $10^{-16} \text{ V}^2/\text{Hz}$  at  $f = 100 \text{ Hz}$  and at an amplification up to 1000 V/V [11]. The inherent noise of the proposed amplifier is still much lower than the observed noise of gas sensors (Table 1) even when its input resistance reaches tens of  $k\Omega$ . Additionally, this solution is convenient because it needs only a single supply voltage that is contradictory to two independent supply voltages when operational amplifiers are used.

#### 4. Measurement results and prospective applications

The results of noise measurements using the described system for TGS commercial sensors confirmed that fluctuation-enhanced gas sensing can be applied in practice by using a cheap low-noise voltage amplifier and the presented bias circuit. We conclude as well that the sampling can be done even by an ordinary microcontroller with A/D converter of 10-bit resolution only. This means that the presently produced gas detection systems that use cheap microcontrollers can be simply modified to improve gas detection by additional noise measurements.

The results of noise measurements for the sensor TGS 826 at ambient atmosphere of synthetic air and at various sensor polarization voltages  $U_{DC}$  are presented in Fig. 6. We deduce that the measurements can be done even at  $U_{DC} = 1 \text{ V}$  although interferences at 50 Hz

dominate in the low frequency range. Additionally, the intensity of these interferences changed due to mains load and as consequence power supply quality. Moreover, sometimes only second- or third-harmonic components of power supplies dominated (Fig. 7). It is worth to mention that there was no advanced or active screening of the circuit or expensive galvanic isolation between stages of the measurement system.

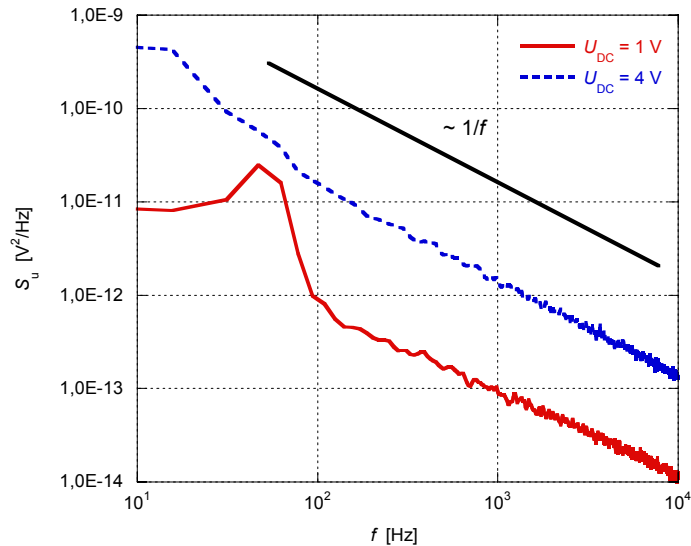

Fig. 6. Voltage power spectra  $S_u(f)$  recorded for commercial gas sensor TGS 826 exposed to ambient atmosphere of synthetic air at various DC voltages  $U_{DC}$  across the sensor.

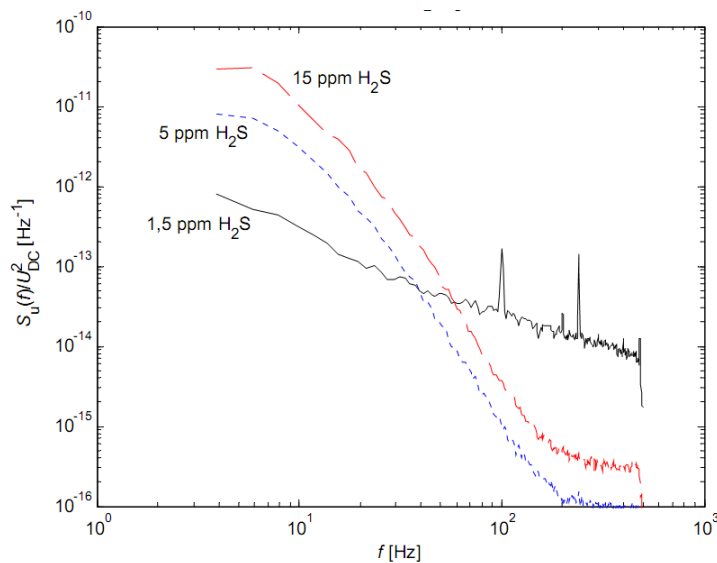

Fig. 7. Voltage power spectra  $S_u(f)$  of gas sensor TGS 2602 normalized to the square of its DC voltage  $U_{DC}$  at ambient atmosphere of various  $H_2S$  concentration.

The investigated sensors exhibited various reactions to various gases. The voltage power spectrum changed its intensity and shape as well (Fig. 7). Therefore, in practical applications signal processing can be limited to necessary scaling and filtering within two or three selected bandwidths. This processing is not expensive computationally as the power spectrum estimation.

When the prototype sensors are considered, we were able to observe noise within the bandwidth of a few hundred Hz only. Additionally, the huge sensor DC resistance enabled easier penetration of interferences caused by power supply lines [6]. We suppose that better results could be expected by applying more efficient screening and grounding, that means higher costs.

## 5. Conclusions

Cheap systems of voltage noise measurements across polarized gas sensors were proposed. The measurement results suggest that fluctuation-enhanced gas sensing can be introduced in the produced gas detection systems that utilize TGS gas sensors and ordinary microcontrollers. The proposed system comprises a bias circuit, a cheap low-noise voltage amplifier and a sampling unit with a low resolution A/D converter and some digital processing to get the normalized parameter  $S_u(f)/U_{DC}^2$  estimated within two or three selected bandwidths. Moreover, a faster microcontroller would allow more advanced data fitting [12].

When the prototype monosized nanoparticle gas sensors are considered, the measurements are more difficult due to higher sensor DC resistance. It can be supposed that more careful screening and grounding would help. These sensors demonstrate much greater values of  $S_u(f)/U_{DC}^2$  due to the smaller number  $N$  of atoms within the sample and smaller grain size, and therefore it is worth to look for more complicated methods of measurements than in the case of TGS sensors.

## References

1. N. Taguchi: US Patent no. 3 631436, 1971.
2. K. Ihokura, J. Watson: *The stannic oxide gas sensors. Principles and applications*. CRC Press, Florida, USA, 1994.
3. L.B. Kish, R. Vajtai, C.G. Granqvist: "Extracting information from noise spectra of chemical sensors: single sensor electronic noses and tongues". *Sensors and Actuators B* 71, 2000, pp. 55-59.
4. J. Smulko, L.B. Kish, G. Schmera: "Application of nonlinearity measures to chemical sensor signals". *Proc. SPIE, Noise and Information in Nanoelectronics, Sensors and Standards*. Santa Fe, USA, vol. 5115, 2-4 June 2003, pp. 92-100.
5. S. Gomri, J.L. Seguin, J. Guerin, K. Aguir: "A mobility and free carriers density fluctuations based model of adsorption-desorption noise in gas sensor". *Journal of Physics D – Applied Physics*, vol. 41, no. 6, March 2008, pp. 065501-065511.
6. J. Ederth, J. Smulko, L.B. Kish, P. Heszler, C. Granqvist: "Comparison of classical and fluctuation-enhanced gas sensing with Pd<sub>x</sub>WO<sub>3</sub> nanoparticle films". *Sensors & Actuators B*, vol. 113, 2005, pp. 310-315.
7. L. Hasse, L. Spiralski: *Szumy elementów i układów elektronicznych*. WNiT, Warszawa, 1981. (in Polish)
8. W. Kiciński: "Problems of underwater noise measurements". *Prace PIE* 2000, no. 140, 2000.
9. L. Kiss, T.G.M. Kleinpenning: "Interpretation of Hooge's 1/f noise formula". *Physica B* 145, 1987, pp. 185-189.
10. J. Smulko, J. Ederth, L. Yingfeng, L.B. Kish, M. Kennedy, F. Krus: "Gas-Sensing by Thermoelectric Voltage Fluctuations in SnO<sub>2</sub> Nanoparticle Films". *Sensors & Actuators B*, vol. 106, 2005, pp. 708-712.
11. J. Smulko: "The measurement setup for gas detection by resistance fluctuations of gas sensors". *IMTC 2006 Instrumentation and Measurement Technology Conference Sorrento*, Italy, 24-27 April, 2006, pp. 2028-2031.
12. M. Poniatowska: "Determining the uncertainty of fitting discrete measurement data to a nominal surface". *Metrol Meast Syst*, vol. 15, no. 4, 2008, pp. 595-606.